

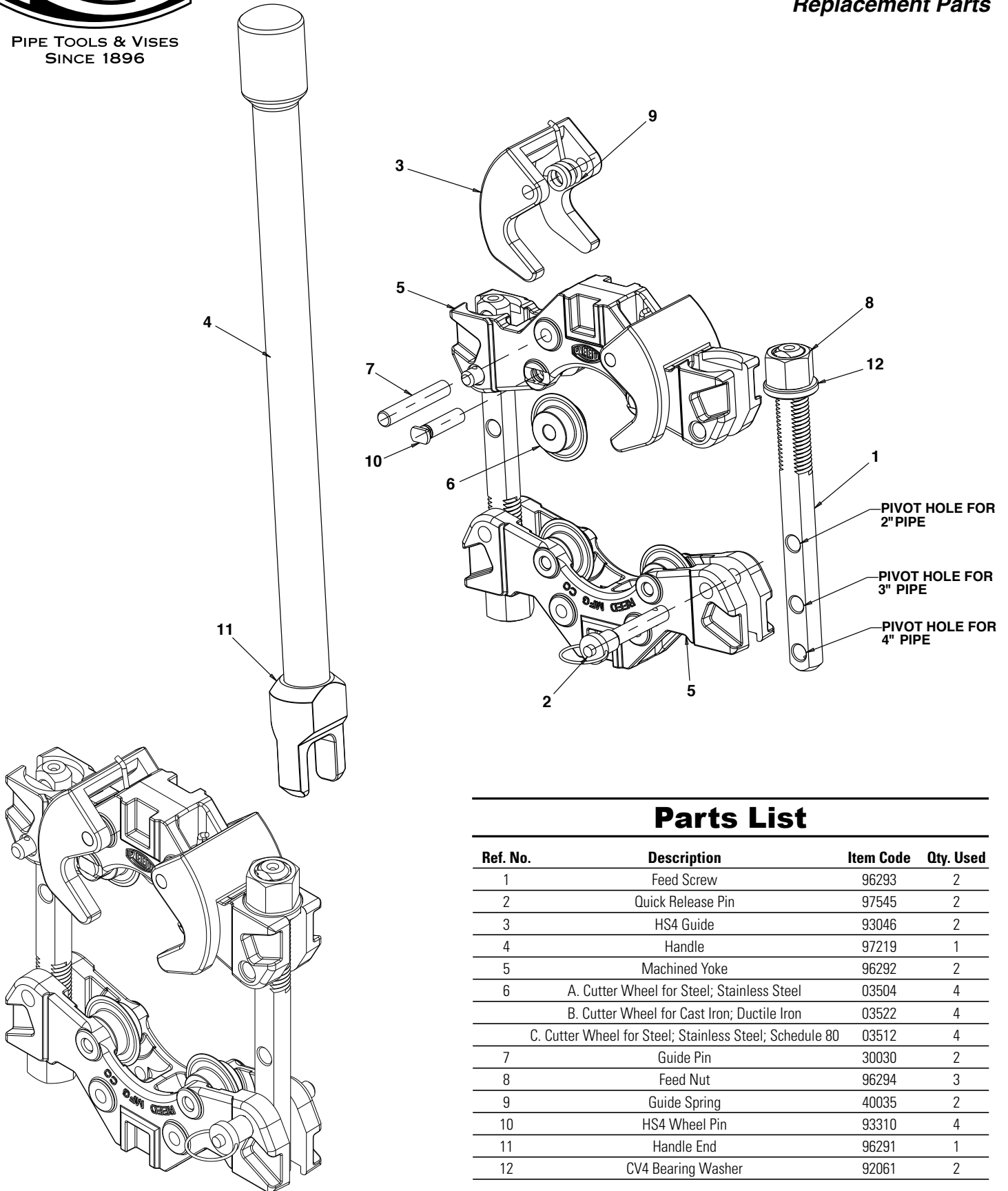

PIPE TOOLS & VISES
SINCE 1896

LCRC4 Rotary Cutter

Replacement Parts



Parts List

Ref. No.	Description	Item Code	Qty. Used
1	Feed Screw	96293	2
2	Quick Release Pin	97545	2
3	HS4 Guide	93046	2
4	Handle	97219	1
5	Machined Yoke	96292	2
6	A. Cutter Wheel for Steel; Stainless Steel	03504	4
	B. Cutter Wheel for Cast Iron; Ductile Iron	03522	4
	C. Cutter Wheel for Steel; Stainless Steel; Schedule 80	03512	4
7	Guide Pin	30030	2
8	Feed Nut	96294	3
9	Guide Spring	40035	2
10	HS4 Wheel Pin	93310	4
11	Handle End	96291	1
12	CV4 Bearing Washer	92061	2

Reed Manufacturing Company
1425 West 8th Street
Erie, PA 16502 USA

QUALITY
& Service
that Last a Lifetime

Phone: 800-666-3691 or 814-452-3691
Fax: 800-456-1697 or 814-455-1697
www.reedmfgco.com